



# Manual

# Digital Chlorophyll Content Meter

clorofi**LOG**

**CFL2060**

Revision B

05/2023

MAN\_CFL2060

All rights reserved.  
**Falker Automação Agrícola Ltda.**

Copying by any means of this document or part of it without prior written authorization is expressly prohibited.

Falker reserves the right to make changes to this document or the equipment without prior notice. The information contained in this document is the most current at the time of publication and is provided to facilitate the use of the equipment.

Although every precaution has been taken in the preparation of this document, Falker assumes no responsibility for any errors or omissions, and no liability is assumed for damages resulting from the use of the information contained in this manual.

---

To make easy the comprehension and highlight important aspects, some information receive special formatting, as indicated below.

**Note:**

Present some detail or better explanation of some point of the text

**ATTENTION:**

Indicate points that should be observed by user to a correct use and maintenance of the device.

**CAUTION:**

**Warn about situations that can permanently damage the device or cause other serious damages.**

---

[www.falker.com.br](http://www.falker.com.br)

[falker@falker.com.br](mailto:falker@falker.com.br)

## Índice

1	Introduction.....	4
2	The equipment.....	5
2.1	Accessories.....	6
3	Operation.....	6
3.1	First use.....	6
3.2	Basic operation.....	7
3.3	Data acquisition.....	8
3.4	Data visualisation.....	11
3.5	Manage.....	12
3.6	Bluetooth.....	15
3.7	Settings.....	15
3.8	Internal GPS.....	16
3.9	Screens.....	16
3.10	Falker Leaf – Visualisation and data analysis.....	18
3.11	Data transfer.....	19
4	Basic maintenance.....	20
4.1	Battery charging.....	20
4.2	Device cleaning.....	20
4.3	Software atualization.....	20
4.4	Another questions.....	21
5	Technical specifications.....	22
5.1	User Messages.....	22
5.2	Dimensional information.....	23
5.3	Anatel homologation for equipment CFL2060.....	23
5.4	CE and FCC marking for equipment CFL2060i.....	23

## 1 Introduction

---

The clorofiLOG - Digital Chlorophyll Content Meter - is an that allows the user to identify the crop health condition in a simple and direct form. The chlorophyll content is proportional to fundamental nutrients, as nitrogen. By using the clorofiLOG is possible to identify and correct crop shortcomings directly in field.

The measurement is done by optical form, using scientific knowledge of the light frequencies that chlorophyll processes best in photosynthesis. With exclusive technology, clorofiLOG analyzes 3 light frequency bands in the measurement, allowing a detailed analysis, taking into account the presence of chlorophyll types A and B.

This manual covers all aspects related to the use of the equipment and guidelines for starting to use the Falker Leaf Web Application and App, which allows the visualization and analysis of collected data. However, this document is not an agronomic manual, and does not include post-measurement actions related to the treatment of ICF.

**Thank you for choosing Falker!**



## 2 The equipment

The equipment is supplied in a protection case, suitable for use in the field. The following items are provided:

- Electronic device CFL2060
- Protection case
- Safety wrist strap
- Warranty term
- First use guide
- USB-A to USB-C cable

Figure 1: Device set



**ATTENTION:**

For being an accurate measurement device, the CFL2060 must be transported carefully. The case that is provided was design to protect the equipment when transported, allied with practicality of use. It is not a package for cargo transport

## 2.1 Accessories



In addition to the items that come with the equipment, the following codes can be used to purchase accessories or replacement items.

Table 1: Accessories Comercial Codes

FLK9020	USB-A to USB-C Cable
FLK9030	USB-A output charger

## 3 Operation

### 3.1 First use

To turn on the device, press the on/off  located on the left side of the panel. To turn off, hold down the on/off button  at least for five seconds.

In the first use of the CFL2060, language and local time of operation can be set.

Figure 2: First use screens







To set time, GPS signal is required. If a message of no GPS signal is displayed, go to an outdoor place. If it is not possible to perform this operation, it will be possible to set the time at another moment, in the device settings menu. To start the use without setting time, turn off and turn on the device so the the Gps no signal message will be displayed.

### 3.2 Basic operation

Figure 3: User interface



The operation of the device is done with the following buttons     and the screen, where the measurement values, warnings and user information as the state of charge, memory occupation and GPS signal are displayed.

When turning on the device, after an initialization screen, the main screen appears. The following information is displayed on this screen: battery level and GPS position indication at the top. Also time indication (only when GPS is receiving data) and memory usage are displayed at the bottom.

The memory usage is shown by the icon (memory card) represented by the filling steps, which indicate the memory usage.

The icon with 4 vertical bars indicates the device's GPS signal strength. If it has a signal, the main screen also indicates the time, based on data from the GPS itself.



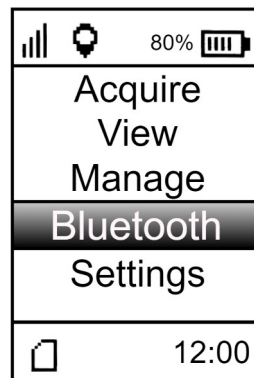

Figure 4: Main screen



In the main screen, there are 5 options:

- **Acquire:** menu used to acquire new data.
- **View:** menu used to visualize acquired.
- **Manage:** menu that allows to set reference, add, edit or delete work.
- **Bluetooth:** menu that allows to enable or disable Bluetooth and display its status.
- **Settings:** menu of the device's settings.

All the above menu offer their own options.

The navigation between the menu options is done by the following buttons  e . The button  selects the chosen option. The button  returns to the previous screen.

### 3.3 Data acquisition

Use the “Acquire” menu to perform measurements.  
After selecting the “Acquire” menu, the work selection screen will be opened, as shown in the figure 5 below.

Figure 5: Work selection

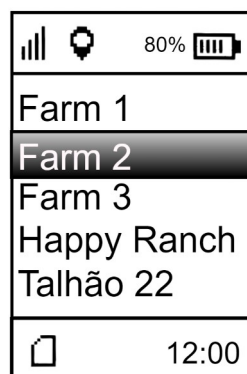



After selecting the desired work, the following screen will be displayed:

Figure 6: "New day" or "Continue" screen

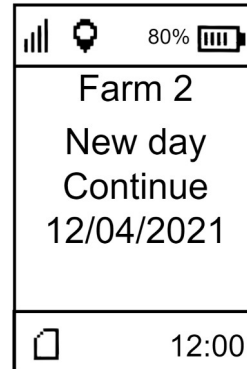

There is the option to continue one day work or start a new day. After selection, the calibration screen will open.

Figure 7: Calibration screen

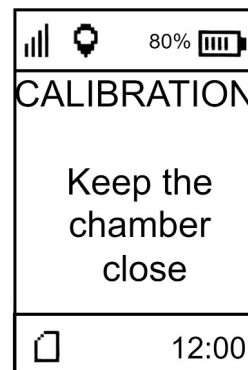

To perform the calibration, the chamber must remain closed for up to 6 seconds, empty without any leaf inside. Once the calibration is finished the screen as shown in figure 8 below will open.

Figure 8: Calibration confirm screen

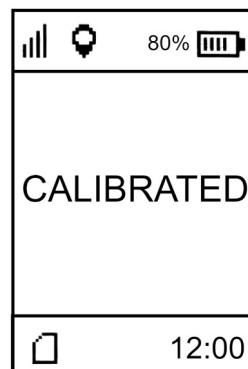

**Note:**

Device calibration will be requested whenever the user turns on the device and starts the measurement process

After performing the calibration procedure, the equipment will be ready to perform measurements. A screen with the data of the last measurement performed will be presented to the user. If it is the first measurement, the screen displayed will be like the figure 9 below.

Figure 9: Measurement screen

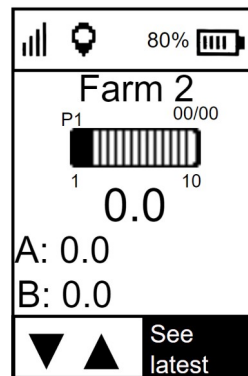

Obtaining data with clorofiLOG is a quick and simple procedure.

With the measurement chamber open, place the leaf to be measured.

Keep the measurement chamber closed for 2 seconds, until the equipment emits two short beeps, indicating that the measurement has been performed. Release the chamber so that it returns to its starting position.

The data obtained in the measurement, as well as its attributes, are automatically stored in the device's memory. If the data has been obtained in an erroneous way, the user can erase it and redo the measurement. In the measurement screen, using the directional buttons, four resources can be access.

Figure 10: Resources of the measurement screen

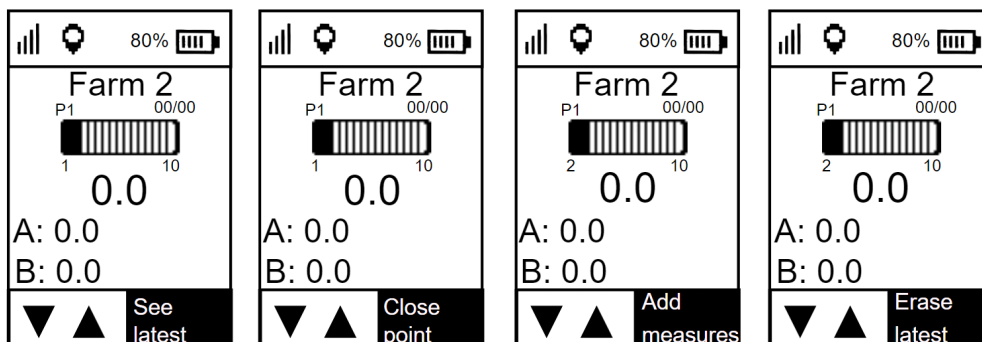

- **See latest:** feature used to check measurements taken at the current point.
- **Close point:** ends measurements at the current point.

- **Add measures:** adds one more measurement to the current point.
- **Erase latest:** delete the last measurement at the current point.

**CAUTION:**  
Never obstruct or place any type of material on the measurement chamber closing sensor. This could permanently damage it or cause other serious damage. In addition, the measurements will have their results wrong, not corresponding with the actual chlorophyll content existing in the leaf.

**CAUTION:**  
For equipment conservation, avoid impacts, falls and exposure to rain

### 3.4 Data visualisation

The clorofiLOG has basic resources for the data visualisation in the equipment itself, without the need for data transfer.

In the “View” menu, the work selection will be displayed. After the work selection, the date selection shown in the figure below will be opened

Figure 11: Home screens for choosing the point to be viewed

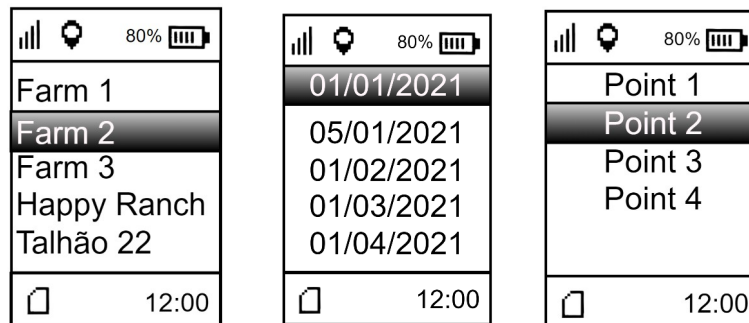

After selecting the point, the measurement preview screen opens.

Figure 12: View point measurements

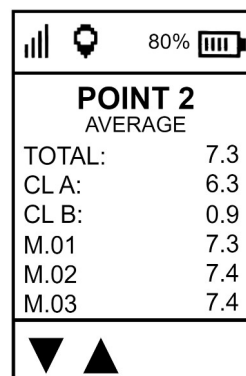

In “TOTAL”, the average of chlorophyll of Lall measurements performed at the point in question is displayed. In “CL A” the average of chlorophyll A of all measurements at the point is displayed. In “CL B”, the average of chlorophyll B of all measurements at the point is presented. At the bottom, the total result of chlorophyll in each measurement performed at the point is shown.

When selecting one of the measures at the bottom, the following screen will be displayed as shown in figure 13 bellow.

Figure 13: Viewing a point measurement

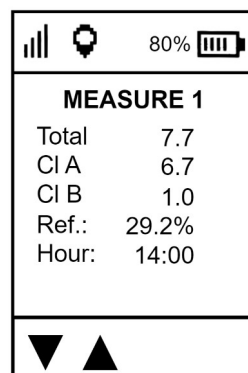

The screen displays the total chlorophyll, chlorophyll A and chlorophyll B results. It also shows how much the total chlorophyll result represents in relation to the average of the chosen reference point. The time at which the measurement was taken is displayed at the bottom.

### 3.5 Manage

When selecting the “Manage” menu, the following screen opens.

Figure 14: “Manage” screen

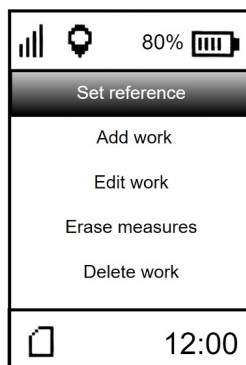

- **Set reference:** sets the average of the measurements of a point as a reference in any measurement view.
- **Add work:** Adds a new work.
- **Edit work:** Edit an existing work.
- **Erase measures:** deletes all measures for a given work.
- **Delete work:** Deletes an existing work.

When clicking on the “Set reference” menu, a screen will appear for choosing the work where the point you want to define as a reference is located. When selecting the work, the screen will appear containing the existing points in that work, using the directional buttons it is possible to choose the desired point. To select the desired point, use the enter key.

Figure 15: Set reference

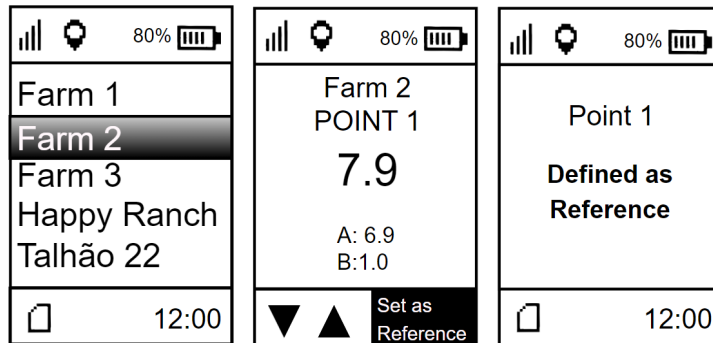

By clicking on the “Add work” menu, the screen for choosing the name of the new work will open. To choose the letters, use the directional arrows. To confirm the letter, use the enter key. After choosing the name, the screen for choosing the number of points that will compose the new work is opened. Finally, it is necessary to choose the number of measurements that will be part of each point. The figure 16 below shows the chaining of screens in the “Add work” menu.

Figure 16: Add work chaining screen

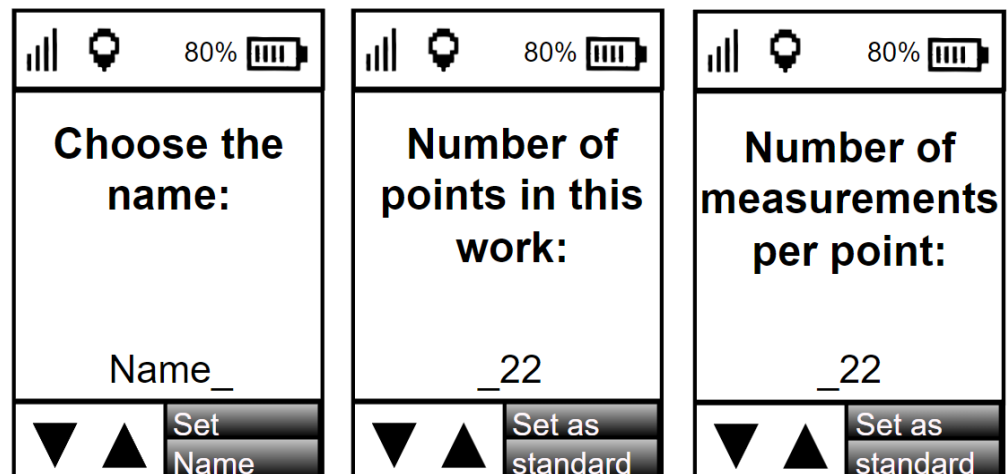

Selecting the “Edit work” menu, it is possible to edit the name, number of points and number of measurements of an existing work. The figure below shows the sequence of screens in the “Edit work” menu.

Figure 17: Edit work

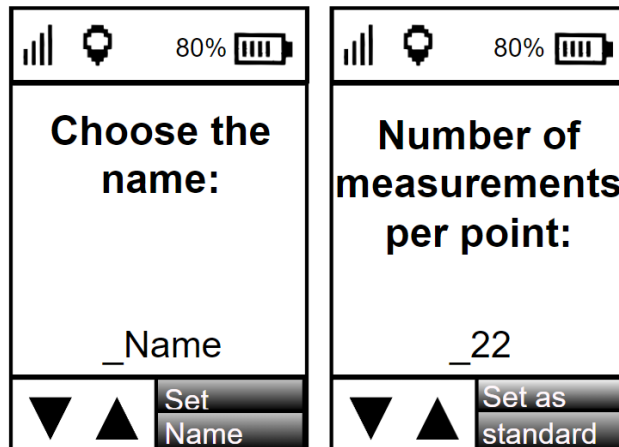

By selecting the “Delete measurements” menu, a warning screen will open informing you that the measurements will be deleted but the structure will remain. On the same screen, confirmation is required to continue. On the next screen, you are asked to select the work that will have its measurements deleted. The last screen is the confirmation of the action. The figure below shows the chaining of screens in the delete measurements menu.

Figure 18: Delete measurements

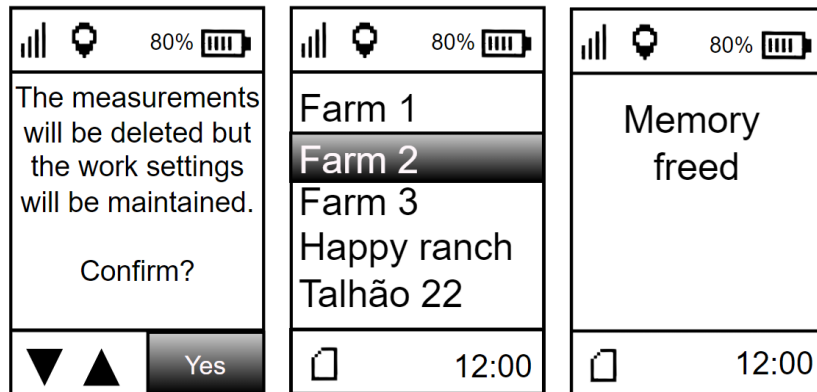

By choosing the “delete work” menu, it is possible to delete the entire structure of a previous work. The first screen that opens tells you what the operation will do and requires confirmation to proceed. On the second screen, the work to be deleted must be chosen. The last screen is confirmation that the action was done correctly.

Figure 19: Delete work

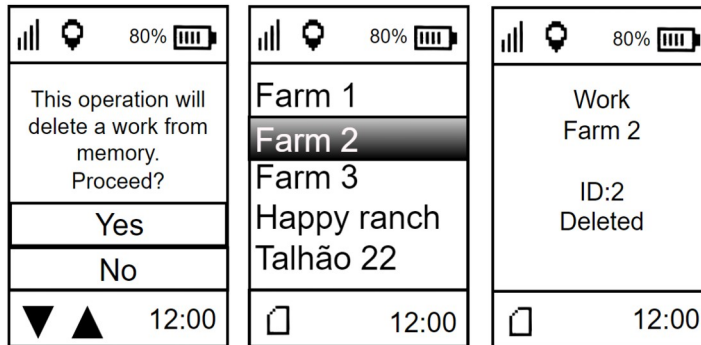

### 3.6 Bluetooth

Selecting the “Bluetooth” menu opens the following options

Figure 20: Bluetooth screen

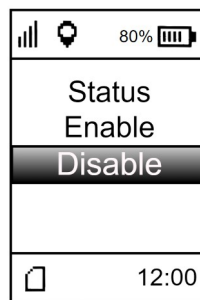

In “status” option it is possible to check if the bluetooth is enabled or disabled. Selecting “enable” the bluetooth will be activated. By selecting “Disable”, bluetooth will be disabled.

### 3.7 Settings

When selecting the settings menu, the following screen opens.

Figure 21: Settings

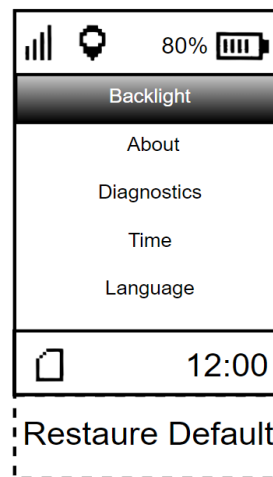

In “Backlight” option it is possible to change the intensity of the equipment screen brightness. In “About” it is possible to check information about how many measurements are stored in the memory, the battery charge level and the battery temperature. In the “Diagnostics” menu some more specific information about the battery, GPS, Memory, Sound, LEDs can be obtained.

### 3.8 Internal GPS

The clorofiLOG model 2060 already has an onboard GPS, which allows all measurements to be georeferenced, and even to record the date and time they were taken. This model does not need an external antenna or cables and accessories for this. As an indication, the clorofiLOG screen will have two icons for checking the GPS signal.





 An icon identifies whether the device was able to calculate the current position. For this, it is necessary, at least, 3 satellites visible by the equipment, because the GPS signal depends on the triangulation between satellites so that the current position is known. Position accuracy will depend on signal quality.

 The other icon identifies the signal strength.

The 4 levels indicate the accuracy of the data acquired by the GPS. For better precision, it is always recommended to wait for the signal to remain with 4 bars, aiming at greater precision in the acquired coordinate. Depending on weather or environmental conditions such as clouds and trees, it may not be possible to get all 4 bars.

### 3.9 Screens

The navigation between the screens is mainly through the keys. Following the navigation scheme of the screens presented below, in addition to performing the Falker chlorophyll index measurements, we can also view these measurements and define the equipment settings.

Navigation between the different screens of the equipment is simple and intuitive, using the keys as commands.  and  to change settings, view measurements, etc., and keys  and  to enter and exit a screen, respectively.





### 3.10 Falker Leaf – Visualisation and data analysis



The Web Application could be access in:

[leaf.falker.com.br](http://leaf.falker.com.br)

And the App is available for Android devices on the Google Play Store. Search for “Falker Leaf”

ClorofiLOG has a specific Web Application and App for viewing and analyzing the collected data.

In an online system, with data saved in the cloud and automatic synchronization between Web and App, you can access information from anywhere for analysis or sharing. It also allows the generation of measurement reports for presentation.

**Note:**

The Falker LEAF System for transferring and analyzing data on the computer is constantly evolving.

Follow the directions directly in the system.



**Relatórios**  
Facilidade de apresentar os dados coletados

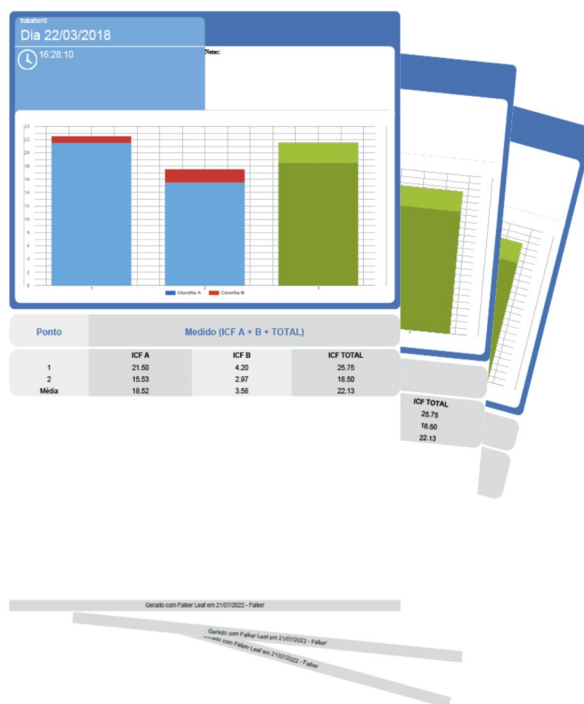

The System also allows customizing and exporting reports for the presentation of measurement results, including graphs, parameters and attributes of the data collected.

### 3.11 Data transfer

Data transfer can be done in two ways:

- **USB cable:** connect a USB cable to the device's USB C output with the device turned off.

The data must then be sent to the Falker Leaf web system using a computer. Windows will open a directory called, "CFL2BOOT" where the file will be available for copying. The file format is ".FC2".

- **Bluetooth:** pair the equipment with a smartphone and transfer the measurements from the equipment to the App via Bluetooth. Whenever the smartphone receives an internet signal, it will automatically synchronize the data in the cloud, in the Falker Leaf system.

## 4 Basic maintenance

### 4.1 Battery charging

The clorofiLOG has an internal battery that must be charged with the original cable, connected to an outlet charger with USB output from a safe source or to a device with USB. Avoid using chargers that are not approved by Organs responsible bodies.

The connector compartment is protected by a sliding cover. Access is by moving the cover to the right.

Figure 23: Output access

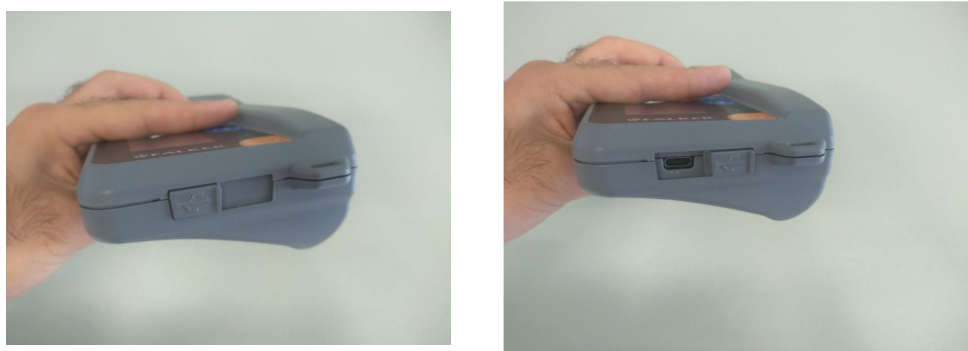

During charging, the red LED is on. When charging is complete, the LED turns off.

### 4.2 Device cleaning



Always keep the equipment clean, removing any dirt resulting from contact with the plants with a dry cloth.

The equipment is not waterproof. However, it has external splash resistance, and care must be taken in the region of the USB C connector.

If there is difficulty in calibration due to dirt in the measuring chamber, it is necessary to clean it using only a small piece of cotton or cotton swab. If necessary, moisten it with water only. Do not use any chemicals.

### 4.3 Software atualization

The equipment's embedded software, which controls its operation, can be updated by the user with files provided by Falker.

For this, one must enter the mode called "Bootloader". With the equipment turned off and disconnected from the charger, keep the keys  and  pressed together. Keeping both keys pressed, turn on the equipment using the key . The equipment will keep the display off or with the "Bootloader" indication. Okay, now the equipment has entered Bootloader mode.

After that, connect the equipment to the computer, using the same charging cable.

The computer will recognize chlorofiLOG as a removable media, which can be located by clicking on "My Computer", in computers with Windows.

Select the file provided by Falker (revxxx.fs2), select the file and drag it to the clorofiLOG folder in "My Computer". The update process will take place automatically, and it only takes a few seconds.

**CAUTION:**

Do not attempt to update using files that you are not sure have been supplied by Falker and are suitable for your device version. Attempting to update with unlisted files may lead to maintenance at Falker.

Updating the equipment software is an existing feature to allow the equipment to be updated and the eventual addition of new functions without the need to return the equipment to Falker.

#### 4.4 Another questions

If you need other maintenance or have questions not covered in this manual, please contact Falker.

[www.falker.com.br](http://www.falker.com.br)

[falker@falker.com.br](mailto:falker@falker.com.br)

In case the above instructions are not enough and the problem persists, please contact Falker.

## 5 Technical specifications

The following table presents the main technical information of the equipment.

**Table 2: Technical specifications**

CFL2060	
<b>Measurement Scale</b>	0 a 100 ICF *
<b>Measurement Resolution</b>	0,1 ICF
<b>Duration of a Measurement</b>	Less than 2 s
<b>Memory Capacity</b>	20.000 measurements
<b>Active Reception Area</b>	9 mm <sup>2</sup>
<b>Measuring Folear Area</b>	50,3 mm <sup>2</sup>
<b>Temperature Compensation</b>	Yes
<b>Operating Temperature</b>	0 a 50 °C
<b>Battery</b>	Rechargeble and internal battery with USB-C output
<b>Battery Capacity</b>	More then 20 hours of use
<b>Indications to the user</b>	LCD screen 64 x 128 pixels Sound indication
<b>Buttons</b>	4 operation buttons 1 on / off
<b>Weight</b>	250 g (with battery)
<b>GPS</b>	Internal
<b>Comunication</b>	USB e Bluetooth

\* To calculate the ICF, the chlorophyll levels of types A and B are considered, made possible by the combination of the analyzed wavelengths of light. In some situations the measurement value may exceed 100 ICF.

### 5.1 User Messages

CFL2060	
<b>Canceled operation</b>	Chamber was open before the measurement was done
<b>High zero</b>	Chamber not close, entering luminosity
<b>Empty chamber</b>	Leaf not detected in measurement chamber
<b>Out of scale</b>	Measurement out of device chlorophyll scale
<b>Blocked chamber</b>	Obstruction found inside chamber during calibration

## 5.2 Dimensional information

Equipment dimensions are shown in the figure.

Figure 24: Dimensions in mm

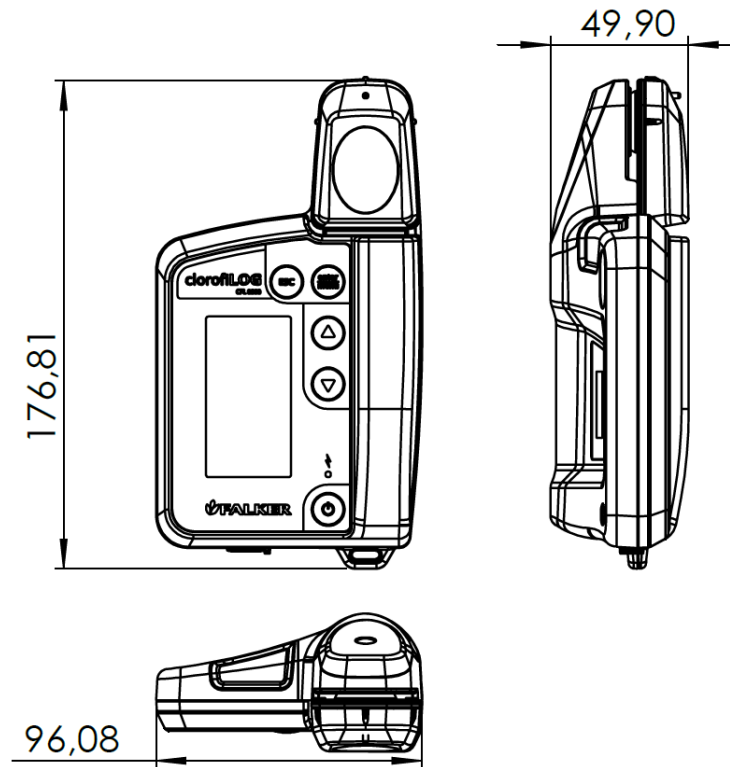

## 5.3 Anatel homologation for equipment CFL2060

This product contains the Bluetooth card approval code 05118-16-10070.



## 5.4 CE and FCC marking for equipment CFL2060i

This product is in conformity with the 2014/53/EU – Radio Equipment Directive (RED) standards EN 55022, EN 61000-4-2, EN 61000-4-3 for CE marking. Also this product is in conformity for FCC.



Contains FCC ID: A8TBM70ABCDEFHG.